



ВБШнгд 3х6-1 ТУ У 31.3-00214534-018-2003

Power cables with copper conductors, with low-flammable PVC-compound insulation, galvanized steel-tape armoured, with PVC-compound protection hose

Cables are used for laying:

- *in bunches*
- *in premises, dry ducts and tunnels, in corrosive environment*
- *in places, where small mechanical impacts on cable are possible, including tensile forces*
- *in bunches, in crowded places*

Fire safety code in accordance with ДСТУ 4809:2007: ПБ123121000

Products of this mark meet the requirements:

- *single wire cable flame retardance*
- *bunched cable flame retardance category A*
- *toxicity class Tk3 of the combustion products of nonmetallic elements (toxicity index over 120 g/m³)*
- *class ДТк1 on smoke-forming ability by smouldering of non-metallic elements (coefficient of smoke formation from 50 to 500 m²/kg)*
- *class ДПк2 on smoke-forming ability by combustion (minimum luminous flux more than 60 %)*
- *corrosive class Kк1 of combustion products of non-metallic elements (the number of halogen hydrides less than 150 mg/g, pH less than 4.3, specific conductivity more than 10 μS/mm)*

TECHNICAL SPECIFICATIONS

Rated voltage	kV	1
Number and rated area of conductors	mm ²	3 x 6
Phase insulation thickness	mm	1
Permissible continuous current rating (AC of industrial frequency) *		
• <i>by aerial laying</i>	A	46
• <i>by burial</i>	A	59
Maximum permissible conductor temperature		
• <i>Continuous</i>	°C	+70
• <i>in emergency operation</i>	°C	+80
• <i>at short circuit</i>	°C	+130
Operating temperature range	°C	-50 ... +50
Minimum bending radius by laying	mm	142.5
Rated outer diameter of the cable (for reference) **	mm	19
Cable weight (approximate)	kg/km	650
Rated factory cable length and gross weight of the delivery on the drums ***	m, t	# 12: 910 • 0.7

Notes:

When ordering it is necessary to agree the factory length of the product with the manufacturer

* Long permissible current loads are calculated for the following conditions: air temperature plus 25 °C, soil temperature plus 15 °C, thermal resistivity of soil 1.2 °K·m/W, laying depth in the soil 0.7 m

** The external diameter may differ from the rated up to ± 10 %

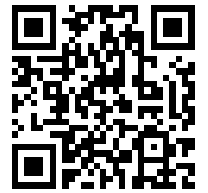

ВБШнгд 3х6-1 ТУ У 31.3-00214534-018-2003

Power cables with copper conductors, with low-flammable PVC-compound insulation, galvanized steel-tape armoured, with PVC-compound protection hose

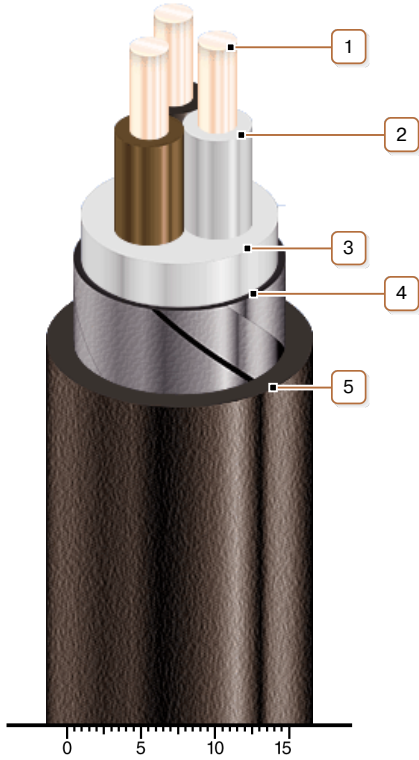

CONSTRUCTION

1. Copper conductor
2. Low fire-risk PVC compound insulation
3. Low fire-risk PVC-compound inner sheath
4. Double galvanized steel-tape armour
5. Pressed off low fire-risk PVC compound protection hose

Note: Conductor twisting is not illustrated