



## **ПВЭСП-220 1x630** **ТУ У 31.3-00214534-061:2008**

Power cables with copper conductor, XLPE-insulated, with copper screen, lead-sheathed, with outer sheath of polyethylene

---

Technical cable requirements correspond to IEC 62067

---

Cables are used for laying:

- *in places, where small mechanical impacts on cable are possible, including tensile forces*
- *in soil (trenches) with high corrosiveness*
- *in damp, partially flooded premises*
- *in ground with high humidity*
- *in wetlands*
- *in non-navigable waters*
- *in the air, including cable structures, if provided the additional fire protection*

---

It is possible to manufacture cables with extruded semiconductor layer along outer sheath.

Order entry example:

ПВЭСП-П-220 1x630/95 ТУ У 31.3-00214534-061:2008

An extruded semiconductor layer along outer sheath ensures the correct testing of cable line with sections of underground laying in polymer pipes.

---

It is possible to manufacture cables with an integrated fiber-optic module.

Order entry example:

ПВЭСП-220 1x630/95 (OM) ТУ У 31.3-00214534-061:2008

In conjunction with the DTS system, the integrated fiber-optic module can act as a distributed cable line temperature sensor.

---

It is possible to manufacture cable with sealed conductor.

Order entry example:

ПВЭСП-220 1x630/95 (r) ТУ У 31.3-00214534-061:2008

---

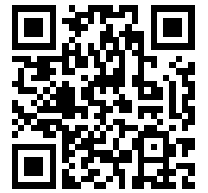

## ПВЭСП-220 1x630 TY Y 31.3-00214534-061:2008

Power cables with copper conductor, XLPE-insulated, with copper screen, lead-sheathed, with outer sheath of polyethylene

### TECHNICAL SPECIFICATIONS

Rated voltage	kV	220
Maximum voltage	kV	252
Conductor rated area	mm <sup>2</sup>	630
Sheath thickness	mm	3.5
Partial discharge factor for rated voltage, not more than	pC	6
Maximum permissible short-circuit current in core	kA	90.1
Permissible continuous current rating by aerial laying *		
• in trefoil formation with double-side screen earthing	A	1044
• in trefoil formation with single-side screen earthing or cross screen earthing	A	1112
• plane with double-side screen earthing	A	1023
• plane with single-side screen earthing or cross screen earthing	A	1270
Permissible continuous current rating by burial *		
• in trefoil formation with double-side screen earthing	A	785
• in trefoil formation with single-side screen earthing or cross screen earthing	A	862
• plane with double-side screen earthing	A	690
• plane with single-side screen earthing or cross screen earthing	A	910
Maximum permissible conductor temperature		
• Continuous	°C	+90
• in emergency operation	°C	+130
• at short circuit	°C	+250
Operating temperature range	°C	-60 ... +50
Minimum bending radius by laying	mm	2525
Rated outer diameter of the cable (for reference) **	mm	101
Cable weight (approximate)	kg/km	24240

#### Notes:

When ordering it is necessary to agree the factory length of the product with the manufacturer

\* Long permissible current loads are calculated for the following conditions: conductor temperature 90 °C, air temperature 30 °C, soil temperature 20 °C, load factor 1.0, thermal resistivity of soil 1.0 °K·m/W, laying depth in the ground 1.5 m, while laying in flat formation the distance between cables in clear is equal to the cable diameter, while laying in trefoil formation cables are laid side by side

\*\* The external diameter may differ from the rated up to ± 10 %



## **ПВЭСП-220 1x630** **ТУ У 31.3-00214534-061:2008**

Power cables with copper conductor, XLPE-insulated, with copper screen, lead-sheathed, with outer sheath of polyethylene

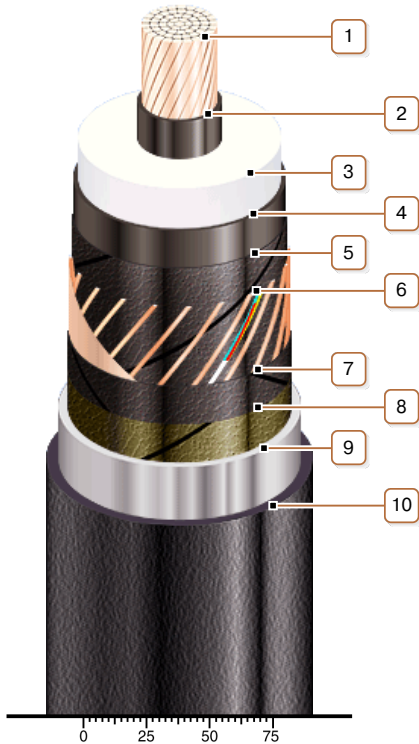

### **CONSTRUCTION**

**1. Copper multiwire compact conductor**

*Note: It is possible to manufacture cable with sealed conductor.*

**2. Inner extruded semiconducting layer**

**3. XLPE insulation**

**4. Outer extruded semiconducting layer**

**5. Lapping layer of semiconductive swellable tape**

**6. Copper screen with an integrated fiber-optic module (optional)**

**7. Lapping layer of semiconductive swellable tape**

**8. Lapping layer of semiconductive tape**

**9. Lead sheath**

**10. Outer sheath of polyethylene or polyethylene copolymer**

*Note: It is possible to manufacture cable with extruded semiconductor layer along outer sheath*