



ПВЭАкПнг-30 1x185 ТУ У 31.3-00214534-058:2007

Single-core power cables with copper conductor, flame-retardant, with XLPE, aluminium-wire armoured, with polymer compound outer sheath

Due to non-magnetic armour, cables operate at AC
Technical cable requirements correspond to IEC 60502-2

Cables are used for laying:

- *in places, where small mechanical impacts on cable are possible, including tensile forces*
- *in premises, tunnels, ducts, mines, dry soil and outdoor under shelter*
- *single laying*

It is possible to manufacture cables with extruded semiconductor layer along outer sheath.

Order entry example:

ПВЭАкПнг-П-30 1x185/25 ТУ У 31.3-00214534-058:2007

An extruded semiconductor layer along outer sheath ensures the correct testing of cable line with sections of underground laying in polymer pipes.

It is possible to manufacture cables with an integrated fiber-optic module.

Order entry example:

ПВЭАкПнг-30 1x185/25 (ОМ) ТУ У 31.3-00214534-058:2007

In conjunction with the DTS system, the integrated fiber-optic module can act as a distributed cable line temperature sensor.

It is possible to manufacture cable with sealed conductor.

Order entry example:

ПВЭАкПнг-30 1x185/25 (г) ТУ У 31.3-00214534-058:2007

It is possible manufacturing of cables in versions (A) and (B), flame-retardant when laying in bunches

Fire safety code in accordance with ДСТУ 4809:2007: ПБ101122000

Products of this mark meet the requirements:

- *single wire cable flame retardance*
- *toxicity class Tk1 of the combustion products of nonmetallic elements (toxicity index from 13 up to 40 g/m³)*
- *class ДТк1 on smoke-forming ability by smouldering of non-metallic elements (coefficient of smoke formation from 50 to 500 m²/kg)*
- *class ДПк2 on smoke-forming ability by combustion (minimum luminous flux more than 60 %)*
- *corrosive class Кк2 of combustion products of non-metallic elements (the number of halogen hydrides less than 150 mg/g, pH more than 4.3, specific conductivity less than 10 μS/mm)*



ПВЭАкПнг-30 1x185 ТУ У 31.3-00214534-058:2007

Single-core power cables with copper conductor, flame-retardant, with XLPE, aluminium-wire armoured, with polymer compound outer sheath

TECHNICAL SPECIFICATIONS

Rated voltage	kV	30
Maximum voltage	kV	36
Number and rated area of conductors	mm ²	1 x 185
Insulation thickness	mm	8
Minimum screen cross-section	mm ²	25
Permissible short circuit current across the screen of minimum cross-section	kA	5.1
Maximum permissible short-circuit current in core	kA	26.5
Permissible continuous current rating *		
• by aerial laying in trefoil formation	A	543
• by aerial flat laying	A	637
• by burial in trefoil formation	A	406
• by burial flat	A	410
Partial discharge factor for rated voltage, not more than	pC	6
Maximum permissible conductor temperature		
• Continuous	°C	+90
• in emergency operation	°C	+130
• at short circuit	°C	+250
Operating temperature range	°C	-60 ... +50
Minimum bending radius by laying	mm	864
Rated outer diameter of the cable (for reference) **	mm	54
Cable weight (approximate)	kg/km	4270
Rated factory cable length and gross weight of the delivery on the drums ***	m, t	# 22УД-60: 635 • 3.6 # 25УД-90: 1068 • 6.1

Notes:

When ordering it is necessary to agree the factory length of the product with the manufacturer

* Long permissible current loads are calculated for the following conditions: conductor temperature 90 °C, air temperature 30 °C, soil temperature 20 °C, thermal resistivity of soil 1.5 °K·m/W, laying depth in the soil 0.8 m, while laying in flat formation the distance between cables in clear is equal to the cable diameter, while laying in trefoil formation cables are laid side by side, shields are earthed on both ends of the line

** The external diameter may differ from the rated up to ± 10 %

*** Отклонение фактической массы брутто от указанного значения может составлять ± 7 %



ПвЭАкПнг-30 1x185 ТУ У 31.3-00214534-058:2007

Single-core power cables with copper conductor, flame-retardant, with XLPE, aluminium-wire armoured, with polymer compound outer sheath

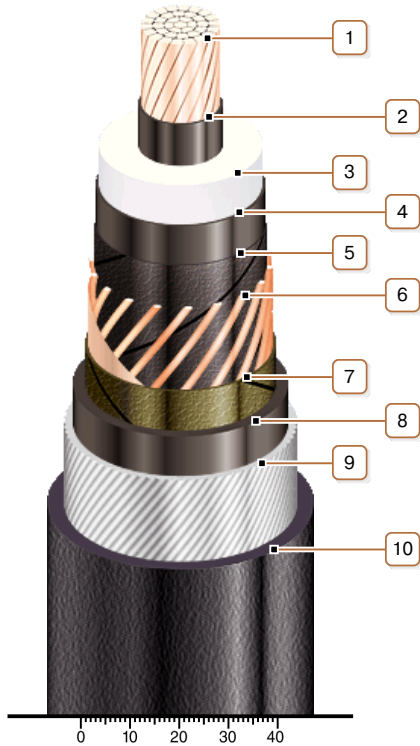

CONSTRUCTION

1. Copper multiwire compact conductor

Note: It is possible to manufacture cable with sealed conductor.

2. Inner extruded semiconducting layer

3. XLPE insulation

4. Outer extruded semiconducting layer

5. Lapping layer of semiconductive swellable tape

6. Copper screen

7. Lapping layer of nonwoven cloth tape

8. Extruded bedding of polyethylene

9. Aluminium-wire armour

10. Flame-retardant polymer compound outer sheath

Note: It is possible to manufacture cable with extruded semiconductor layer along outer sheath